

00PA-399 : PLAQUE ADAPTEUR / ADAPTER PLATE

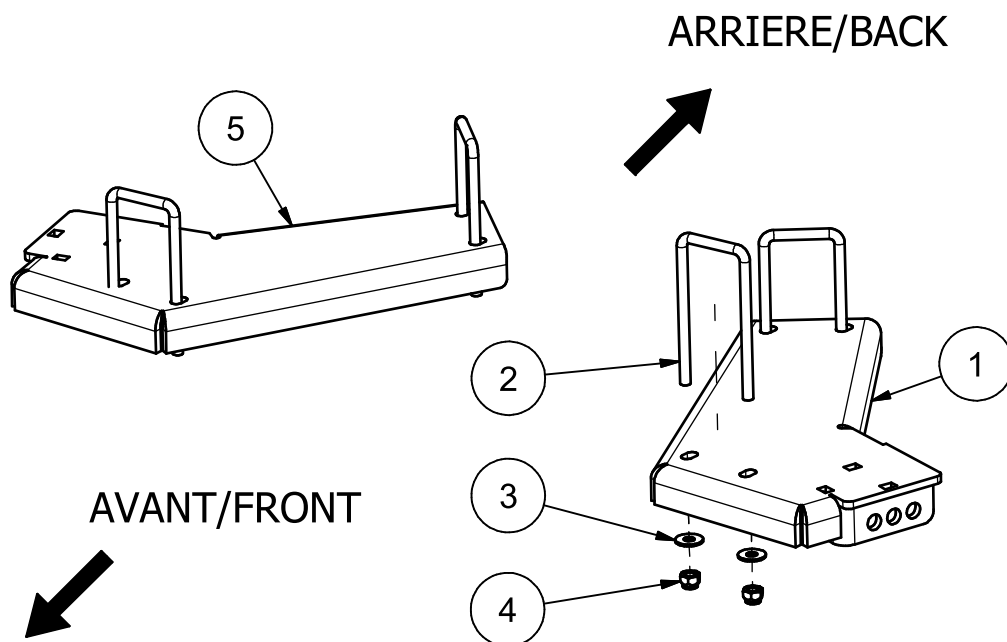

ITEM	QTY	PART NUMBER	RÉV.
1	1	03PA-399G	
2	4	SBUB318-16X2X5	
3	8	FW5116USS	
4	8	HLN3/8-16ZBG2	
5	1	03PA-399D	

2013-05-07



Les Fabrication TJD inc.

147, chemin des Raymond Rivière-du-Loup (Québec), G5R 5X9
www.tjd.ca

PLAQUE D'ADAPTATION / ADAPTER PLATE

00PA-399

Positionnez la plaque sous le véhicule sans la boulonner. Il se pourrait que vous ayez à percer ou à modifier la plaque protectrice sous le véhicule et/ou à percer certains trous dans le châssis. Pour ce faire, servez-vous de la plaque comme d'un guide. Puis boulonnez la plaque en place.

Position the adapter plate underneath the vehicle without screwing it in. You may have to drill or modify the protective plate underneath the vehicle and/or drill holes in the frame as needed. To do so, use the plate as your guide or template. Then firmly screw the plate in place.

