



2021 CAMSO ALL-TERRAIN/ SIDE-BY-SIDE VEHICLES TRACK SYSTEMS





PUSH YOUR VEHICLE'S PERFORMANCE TO THE NEXT LEVEL

You rely on your all-terrain vehicle (ATV) or side-by-side vehicle (UTV) to do more, to get you where you need to go, or to help get that job done.

No matter how rugged your machine is, deep snow, serious mud, and swampy terrain can sometimes be too much for your wheels to handle.

Equip your ATV or UTV with track systems to get reliable year-round mobility.

Get more of what you're driving for

- Expand your mobility and go where you want, when you want
- Reach mind-blowing versatility, stability, and handling on any terrain
- Drive with enough power for heavy hauling and pulling

STAY ON TOP OF WHAT YOU'RE DRIVING



Superior flotation

Where wheels just sink, Camso track systems will keep you moving by distributing your vehicle's weight over a greater surface area.

That means you can go just about anywhere, on any surface.

- Pressure reduced by up to 75%*
- Optimized weight distribution

Average ground pressure

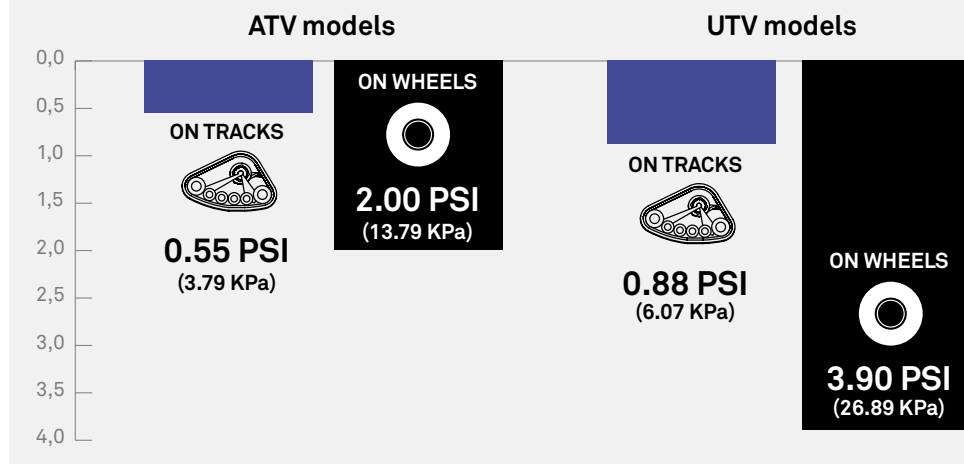

*May vary depending on vehicle weight, load carried and track system model. Calculations based on a 900 lb ATV (including driver) and 1,800 lb UTV (including driver and one passenger).

Outstanding traction

With our tracks and treads specifically designed for ATVs and UTVs, it's hard to get stuck even with the heaviest of loads.

- No compromises on carrying or towing capacity

Responsive handling

Enjoy precise and solid handling; thanks to the track's rigid frame, anti-rotation features, specialized design, and wider, longer wheelbase.

- Less vibration for more comfort
- Low center of gravity and bigger footprint for greater stability



CHANGING YOUR VEHICLE? NO PROBLEM!

You can keep the same track system and install it on your new machine. It's another way to maximize your investment and your driving pleasure.

Drive sprockets geared to your machine

Camsco tailors track systems individually to match your engine and machine. The size of the drive sprockets we provide in your track kit are engineered and adapted to your specific vehicle.

Geared to your machine for efficiency and speed.

Sprockets sized by vehicle **

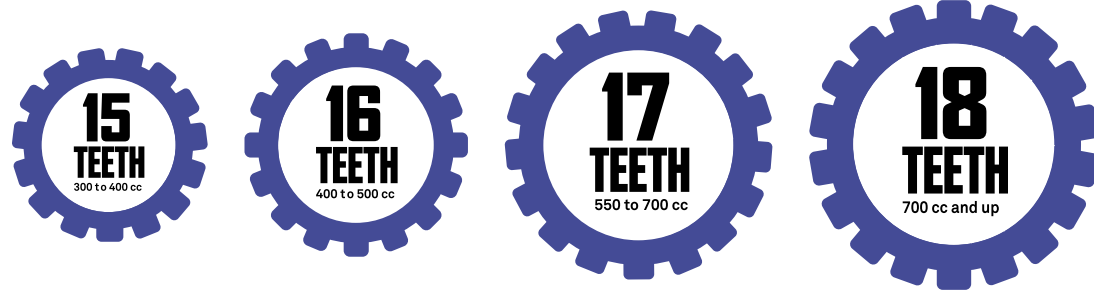

** May vary depending on model.

Anti-rotation and brackets

Our anti-rotation system is designed with a factory pre-loaded spring and dual rubber damper that keeps your tracks firmly in place and ensures your machine's performance.

- Rear track spring anti-rotation system allows you to back up over obstacles
- Built to absorb the impact of every bump and jolt to prevent vehicle damage

Quick and easy installation and removal

With a few basic tools, you can get the recurrent installation done within 2 hours or so.[†] Nonetheless, we recommend that you have an authorized dealer carry out the first installation.



Your Camsco track system is interchangeable with over 99% of brands and models.

THE CAMSO 2021 TRACK SYSTEM LINE-UP FOR ALL-TERRAIN AND SIDE-BY-SIDE VEHICLES

CAMSO
ATV R4S



UP TO 500 CC

CAMSO
ATV T4S



300 CC AND MORE

CAMSO
X4S



300 CC AND MORE

CAMSO
UTV 4S1



400 CC TO 1000 CC

ATV
APPLICATION



UTV
APPLICATION



APPLICATION GUIDE

Whether you use your vehicle for work or recreational purposes, we've got the system to fit your needs.

↑
TRACTION/
FLOATATION
↓

X4S | ATV T4S

ATV R4S | ATV T4S | X4S

UTV 4S1

X4S | UTV 4S1

- Snow making
- Trail grooming
- Spraying
- Logging
- Farming
- Ski patrol

- Recreational activities
- Ice fishing / hunting
- Reaching the cabin
- Snow plowing

CAMSO ATV R4S

Get greater access for less

An all-season ATV track system designed for machines under 500 cc.

Small but mighty, the Camso ATV R4S is versatile and offers great traction with better flotation. The ideal track system to carry lighter loads on flat land and slight slopes.

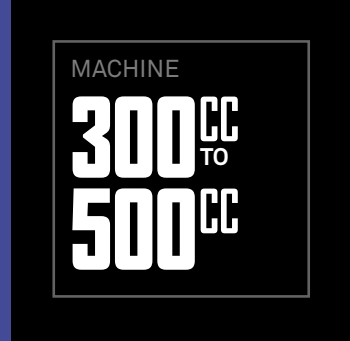

ALL-TERRAIN



SPECIFICATIONS

RUBBER TRACK	
Width	Front: 8 in. (203 mm) Rear: 8 in. (203 mm)
Length	Front: 93.4 in. (2372 mm) Rear: 98.6 in. (2504 mm)
Lug height	Front: 7/8 in. (22 mm) Rear: 1 in. (25 mm)
Rubber track	Front: flat Rear: flat
PERFORMANCE	
Ground surface	1 333 sq. in. (0.86 m ²)
Maintained speed (average)	2/3

Please find more specifications on page 20



8" track width

Specially adapted for small cc ATVs

Ground pressure reduced by 50% vs. tires*

*May vary depending on vehicle weight, load carried and track system model. Calculations based on a 900 lb ATV (including driver).

Lightweight powder coat steel frame

Proven geometry

Overall good performance and handling

Centered rubberized double-bearing idler wheels

High impact resistance

Prevent ice accumulation during winter use

Sprockets

Adapted for smaller-bore ATVs

Adjusted to prevent clutch and engine overload

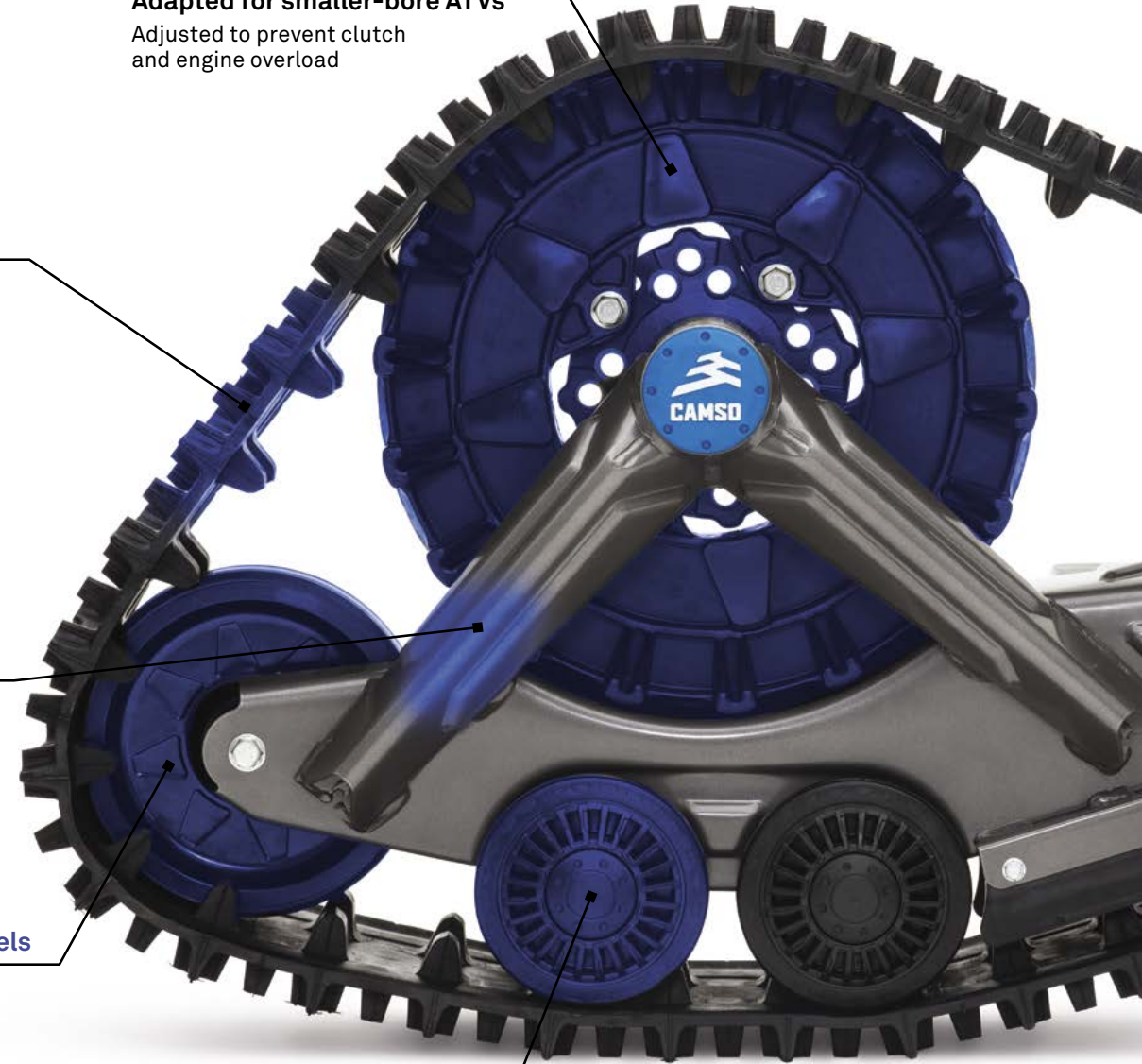

Rubberized and sealed mid-rollers

Increased wheel bearing longevity

Prevent ice accumulation during winter use

CAMSO

ATV T4S

All work, all play, all seasons

An ATV track system that has built its solid reputation thanks to great performance across all conditions.

Experience optimal effectiveness all year long, no matter the weather and your vehicle type.



MACHINE

300^{CC} TO
1000^{CC}



ALL-TERRAIN



SPECIFICATIONS

RUBBER TRACK

Width	Front: 11.5 in. (292 mm) Rear: 12.5 in. (318 mm)
Length	Front: 93.4 in. (2372 mm) Rear: 98.5 in. (2507 mm)
Lug height	Front: 1.25 (32 mm) Rear: 1.25 in. (32 mm)
Rubber track	Front: flex Rear: flat

PERFORMANCE

Ground surface	2000 sq. in. (1.30 m ²)
Maintained speed (average)	2/3

Please find more specifications on page 20

INDUSTRY'S FIRST

Flex-Track design

Front-mounted tracks with flexible sides and slight curve toward the inside

- Stable handling
- More comfortable ride than traditional flat tracks
- Precise steering for pleasant long-distance riding and long working hours

Bearing housing

Outer seals and stainless steel sleeves
Enduring bearing durability
Greater reliability

Solid steel frame

Open light-weight design
Proven durability and performance
Easily sheds snow, mud, and debris

Idler and mid-roller wheels

Sealed wheel and bearing with elastomeric outer band
Provides a longer life in rough conditions
100% ice-free

Tandem stabilizer

Bolt-on tandem mid-roller wheel
Provides a smoother ride by absorbing shocks

Cap

Fitted wheel cap with bladder effect
Eliminates water absorption due to temperature variations



CAMSO
X4S
FOR ALL-TERRAIN VEHICLES

Get the best performance

Whatever your outdoor activities, from work to play, the Camso X4S track system has been designed to meet any usage of an all-terrain vehicle owner.

It is the worry-free solution to get the most performance and enjoyment out of your ATV driving experience.

The Camso X4S is the next generation of track system that provides the ultimate versatility, stability and handling on any terrain all year-round.



MACHINE
**300CC
AND MORE**



ALL-TERRAIN



SPECIFICATIONS

RUBBER TRACK	
Width	Front: 11.5 in. (292 mm) Rear: 12.5 in. (318 mm)
Length	Front: 93.4 in. (2372 mm) Rear: 98.5 in. (2507 mm)
Lug height	Front: 1.25 in. (32 mm) Rear: 1.25 in. (32 mm)
Rubber track	Front: flex Rear: flat
PERFORMANCE	
Ground surface	2000 sq. in. (1.30 m ²)
Maintained speed (average)	2/3

Please find more specifications on page 20

INDUSTRY'S FIRST

Flex-Track design

Front-mounted tracks with flexible sides and slight curve toward the inside

Stable handling
More comfortable ride than traditional flat tracks
Precise steering for pleasant long-distance riding and long working hours

Bearing housing

Double bearing design with oil bath lubrication

Double bearing hubs and oil bath housing for optimum durability

ENGINEERED

Solid steel frame

A geometry that provides better front steering and handling

Idler and mid-roller wheels

26 mm width provides better track support

Double bearing bolted on wheels for easier serviceability
Standard and replaceable sealed bearings for economic maintenance

Idler and mid-roller section view



CAMSO
X4S
FOR SIDE-BY-SIDE VEHICLES

Explore more for less

The Camso X4S track system has been designed to make the most of any outdoor activities on your small to mid-size side-by-side vehicle with 3 seats or less.

It is our most affordable and versatile UTV track system helping you and your family to get the job done around the cabin, while making the most of your recreational activities such as fishing and hunting.

The Camso X4S is the reliable choice to get you where you need to go any day of the year.



MACHINE
**400CC
TO
700CC**



SIDE-BY-SIDE





CAMSO UTV 4S1

Tough and ready for the long haul

This track system reaches the next level of performance in any conditions. You simply won't find another track kit offering this level of ride quality, performance, durability and ease of use. It's the best choice for any applications including deep snow, swamps, marshes, mud and muskeg.

SPECIFICATIONS

RUBBER TRACK

Width	Front: 12.5 in. (318 mm) Rear: 14 in. (356 mm)
Length	Front: 98.5 in. (2507 mm) Rear: 116.7 in. (2964 mm)
Lug height	Front: 1.125 in. (29 mm) Rear: 1.125 in. (29 mm)
Rubber track	Front: flex Rear: flat

PERFORMANCE

Ground surface	2520 sq. in. (1.62 m ²)
Maintained speed (average)	2/3

Please find more specifications on page 20



MACHINE
**400CC TO
1000CC**



INDUSTRY'S FIRST

Flex-Track design

Front-mounted tracks with flexible sides and slight curve toward the inside

- Stable handling
- More comfortable ride than traditional flat tracks
- Precise steering for pleasant long-distance riding and long working hours

Solid steel frame

Open light-weight design

- Proven durability and performance
- Easily sheds snow, mud, and debris

Puncture-proof tires

High-density tire with adjusted shape

- Reduced friction and wear
- Maximizes shock absorption to improve ride quality
- Delivers trouble-free performance

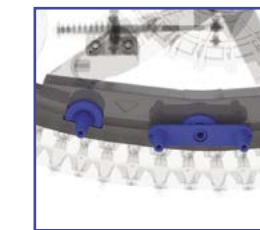

Tandem stabilizer and wheel shaft

Rubber-mounted shafts

- Eliminates need for greasing
- Absorbs shocks for a smoother and more stable ride

Bearing housing

Triple bearing design with oil bath lubrication

- Enduring bearing durability
- Stainless sleeves for greater reliability



Wheel and seal

ENHANCED Wheel seal design

- Sturdy sealing and guiding reduce wear
- Eliminates water absorption due to temperature variations

SYSTEM	CAMSO ATV R4S	CAMSO ATVT4S	CAMSO X4S	CAMSO UTV 4S1
Vehicle size	300 cc to 500 cc	300 cc to 1000 cc	300 cc and more (ATV) 400 cc to 700 cc (UTV)	400 cc to 1000 cc
1 Offset (length)	Front: 25 in. (638 mm) Rear: 26 in. (658 mm)	Front: 24 in. (609 mm) Rear: 27 in. (685 mm)	Front: 24 in. (609 mm) Rear: 27 in. (685 mm)	Front: 26.5 in. (673 mm) Rear: 35 in. (889 mm)
2 Offset (width)	5.5 in. (140 mm)	6 in. (153 mm)	6 in. (153 mm)	7.25 in. (184 mm)
3 Ground clearance	Front height: 15 3/8 in. (390 mm) Rear height: 15 3/8 in. (390 mm)	Front height: 15 3/8 in. (390 mm) Rear height: 14 5/8 in. (372 mm)	Front height: 15 3/8 in. (390 mm) Rear height: 14 5/8 in. (372 mm)	Front height: 16 3/8 in. (416 mm) Rear height: 16 1/2 in. (418 mm)
Weight (average)	60 lb (27 kg)	71 lb (30 kg)	Front: 72.6 lb (33kg) Rear: 79.4 lb (36 kg)	Front: 103 lb (47 kg) Rear: 120 lb (54 kg)
Height	Front: 24 in. (610 mm) Rear: 24 in. (610 mm)	Front: 23.8 in. (604 mm) Rear: 23.2 in. (590 mm)	Front: 23.8 in. (604 mm) Rear: 23.2 in. (590 mm)	Front: 25 in. (637 mm) Rear: 24.7 in. (626 mm)
Length	Front: 40 in. (1016 mm) Rear: 43 in. (1092 mm)	Front: 40 in. (1016 mm) Rear: 42.5 in. (1081 mm)	Front: 40 in. (1016 mm) Rear: 42.5 in. (1081 mm)	Front: 42.5 in. (1081 mm) Rear: 52 in. (1321 mm)
Width	8.4 in. (213 mm)	22 in. (560 mm)	22 in. (560 mm)	25 in. (635 mm)
SPECIFICATIONS				
Drive type	Internal drive	Internal drive	Internal drive	Internal drive
Frame	Carbon steel	Carbon steel	Carbon steel	Carbon steel
Idler and mid-roller wheels/tires	134 mm double bearing and sealed mid-roller wheels. Bladder type wheel cap. 200 mm double bearing	134 and 202 mm encapsulated and sealed wheel including elastomer outer band. Bladder-type wheel cap.	134 and 202 mm double bearings wheel. Standard and replaceable sealed bearings. Elastomer outer band. Bladder-type wheel cap.	132 mm double-bearing mid-roller wheels (width: 50 mm) 241 mm double-bearing flat free tires. Bladder-type wheel cap and face seal.
Hub and bearing	Oiled 2 bearing with cast steel multi-bolt (4-5) pattern hub.	Cast steel multi-bolt (4) pattern hub.	Cast steel multi-bolt (4) pattern hub.	Oiled 3-bearing with forged steel multi-bolt (4-5) pattern hub.
Tandem and suspension	N/A	Mono front tandem on pivot point with bolted wheels.	Mono front tandem on pivot point with bolted wheels.	Rubber mount steel tandem. Rubber mount aluminium shaft axle. Maintenance free.
MAINTENANCE				
Installation time* (average)	2 hrs	2 hrs	2 hrs	2 hrs
Subsequent	1 hr	1 hr	1 hr	1 hr

*We recommend initial installation of Camso track system be performed at an authorized dealer. Installation time may vary depending on vehicle make and model. Certain characteristics may vary depending on vehicle make and model. See product pages for details.

SYSTEM OFFSET AND CLEARANCE

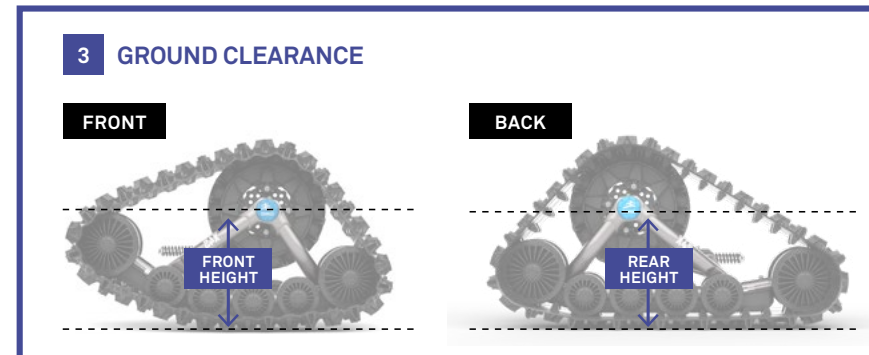
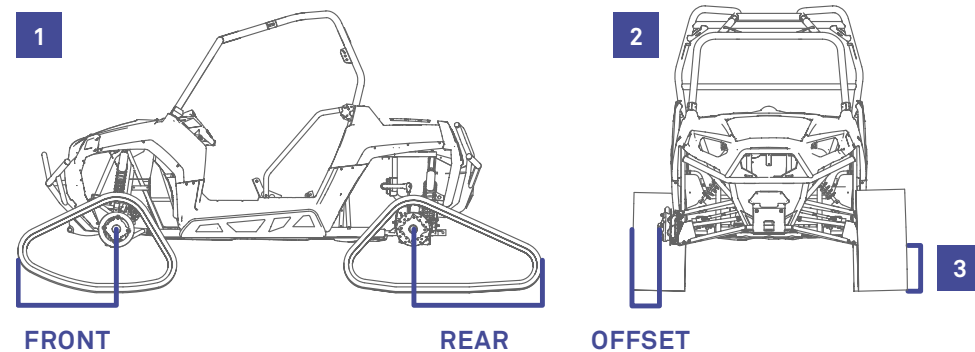

2-YEAR LIMITED WARRANTY

CAMSO TRACK SYSTEMS ARE COVERED BY A BEST-IN-CLASS TWO-YEAR LIMITED WARRANTY.

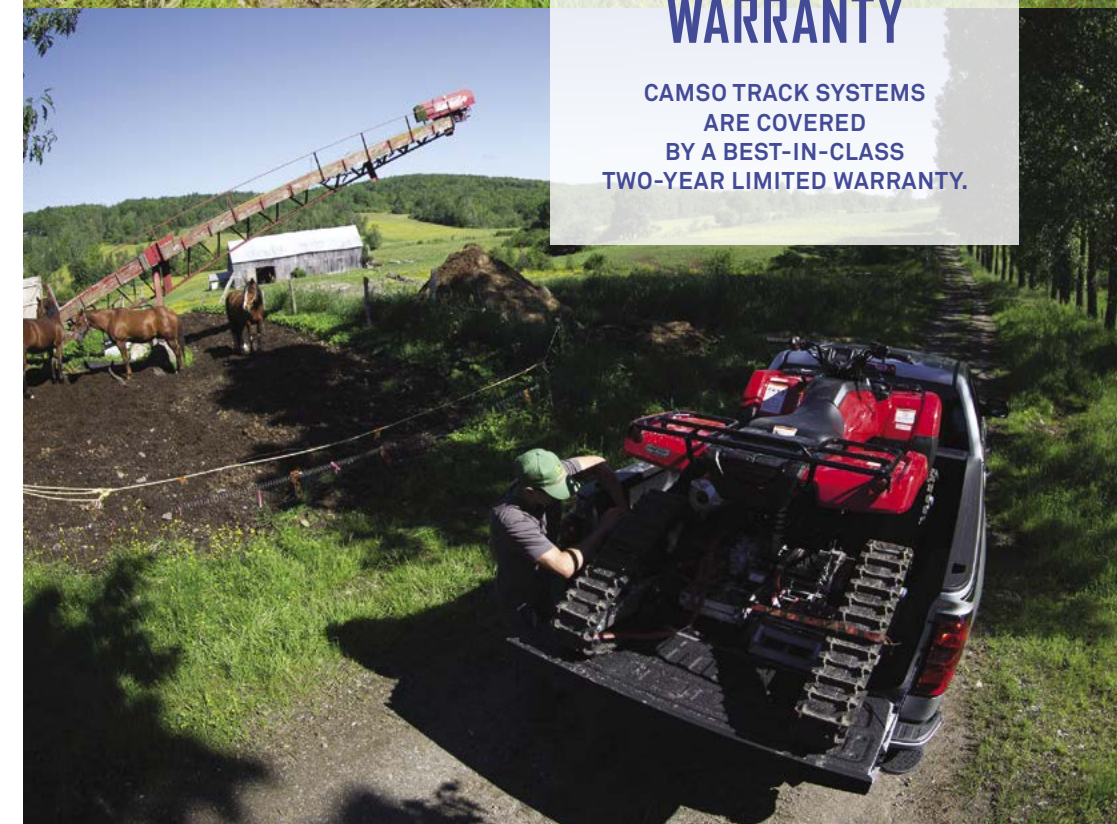

GO FURTHER

A SERVICE WHEN AND WHERE YOU NEED IT

Camso's technical expertise and service are second to none. Wherever in the world you're located, access a Camso expert through one of our many dealers, distributors, or through our direct assistance line.

Camso tracks are covered by a best-in-class warranty. No matter what Camso track you choose, we guarantee long service life, exceptional resistance to damage, low maintenance, and superior traction.

For more information, contact us through our direct assistance line:

1-866-533-0008 (USA and Canada only) | pws.tracksystem@camsco.co

PRINTED IN CANADA 2999-20-0068



**CONNECT WITH US
FOR EXCLUSIVE
ROAD FREE CONTENT**

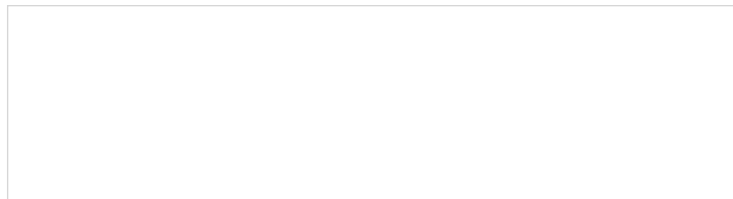

camsco.co

Models, specifications, designs or accessories shown or indicated may change or be discontinued without notice. See your local Camso dealer for details, pricing and availability. Only professionals should install the system onto your vehicle. Modifications to the vehicle may void original equipment manufacturer's warranty. See your vehicle's user manual and warranty. **WARNING:** Riding a ATV or UTV can be dangerous; serious injury, including death, can occur. Read carefully and follow all the instructions in the user manual. Enjoy the off-road safely and responsibly, always wear a helmet and prescribed protective gear and never drink and drive. Some of the images in this brochure are of professional riders under controlled conditions. Do not attempt to replicate. 1 Copyright © 2020 Camso Inc. All rights reserved.

