

TOUGH IS OUR WAY OF LIFE



camsso.co

AUTHORIZED CAMSO TRACK DEALER



2020

CONSTRUCTION TRACKS



In today's economy, good business means making your money go a long way. Camso's goal is to create products that offer Lowest Operating Cost Solutions or LOCS. This is why we are committed to:

- Work closely with equipment owners and operators to ensure we understand the right product for each application
- Design and manufacture the most durable and reliable products available
- Offer our high performance line-up to optimize your productivity and machine performance
- Maximize product availability to increase uptime
- Give the best technical support and service in the industry
- Supply an industry leading non prorated warranty across all of the Camso track range

Find out more at camso.co or contact your authorized local distributor.

COMPLETE TRACK LINE



MINI-EXCAVATORS



**CAMSO
MEX
HXD**



**CAMSO
MEX
SD**



**CAMSO
RUBBER
PADS**



COMPACT TRACK LOADERS



**CAMSO
CTL
HXD**



**CAMSO
CTL
SD**



**CAMSO
CTL
SPROCKET**



OTT TRACKS FOR SKID STEER LOADERS



**CAMSO
RUBBER
OTT**



**CAMSO
STEEL
OTT**



MULTI-TERRAIN LOADERS

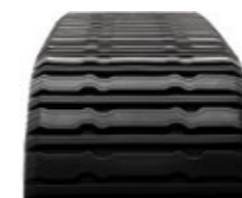

**CAMSO
MTL
HXD**



CARRIERS



**CAMSO
CARRIER
HXD**



PAVERS



**CAMSO
HXD
PAVERS**

MINI-EXCAVATOR TRACKS

EXCEPTIONAL SERVICE LIFE WITH SUPERIOR RESISTANCE TO DAMAGE AND CATASTROPHIC FAILURES



MINI-EXCAVATORS

OVERALL LOSCS GAUGE BY SURFACE TO OBTAIN THE LOWEST OPERATING COST SOLUTION ON THE MARKET

BEST FOR: Heavy Duty Applications requiring exceptional durability

MEX HXD

SURFACE TYPE

MEX SD

BEST FOR: Applications requiring traction in soft surfaces such as clay or mud

HARD SURFACE

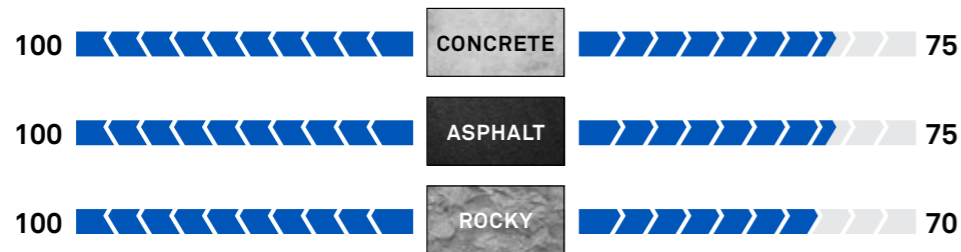

MIXED SURFACE



SOFT SURFACE



ENGINEERED TREAD PATTERNS

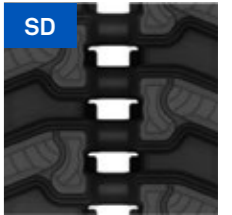

Patented 3S internal metal core

- Prevents detracking
- Minimizes vibrations
- Improves ride quality

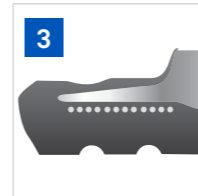

Curbshield technology with reinforced carcass edge

- Fortifies carcass protection
- Impedes catastrophic edge cuts
- Reduces internal components wear exposure



Self cleaning tread design

- Promotes lug-void cleanout for maximum traction
- More traction in reverse driving



Enhanced high-tensile, rubber-sealed steel cables

- Cable corrosion protection
- Strengthens carcass

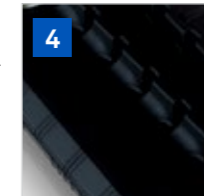

Premium rubber compound and extra thick carcass

- Impact and damage resistance
- Extends service life



Optimized sprocket holes

- Reduces peak load on track and undercarriage parts; allows for sand and debris to pass through with ease

*Check with your dealer for best choice for your application

CAMSO MEX HXD UP TO **50%** MORE SERVICE LIFE
3500 HOURS / 42 MONTHS

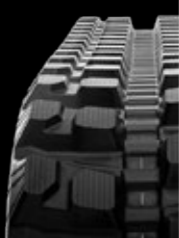

BEST WARRANTY OFFER

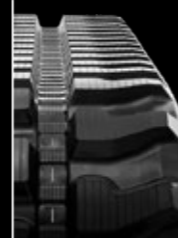

CAMSO MEX SD UP TO **20%** MORE SERVICE LIFE
2500 HOURS / 30 MONTHS

EXCAVATOR PADS

PROVIDE OPTIMAL LIFE AND RESISTANCE AGAINST DAMAGES AND CATASTROPHIC FAILURES



EXCAVATORS

OVERALL PERFORMANCE GAUGE BY SURFACE

HARD SURFACE

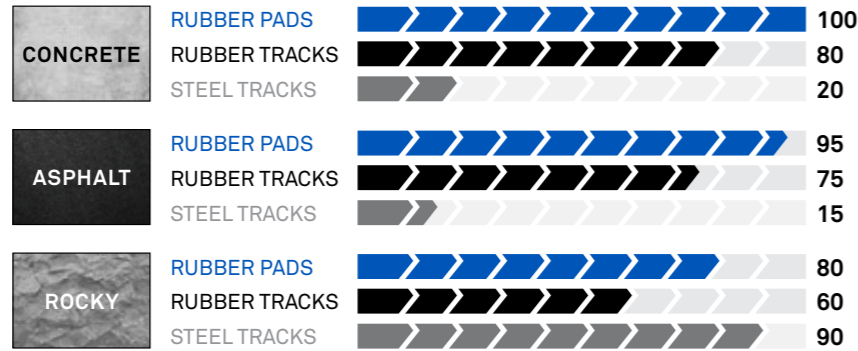

MIXED SURFACE

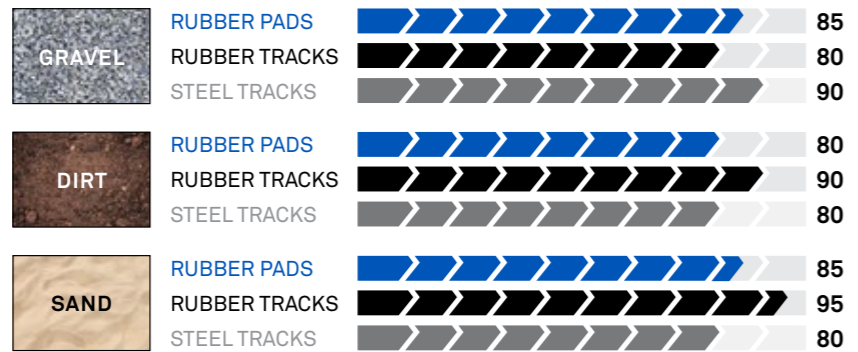

SOFT SURFACE

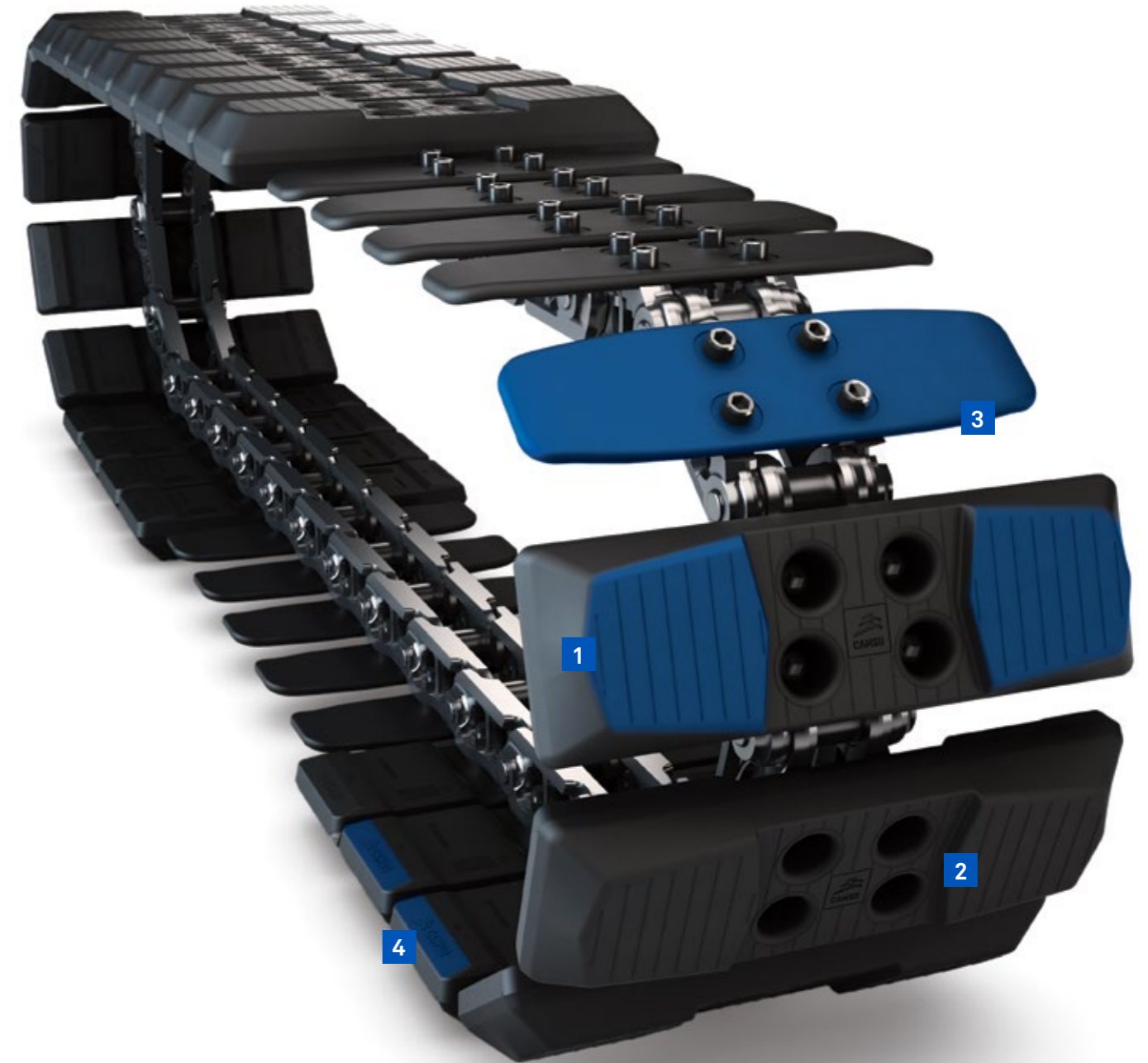
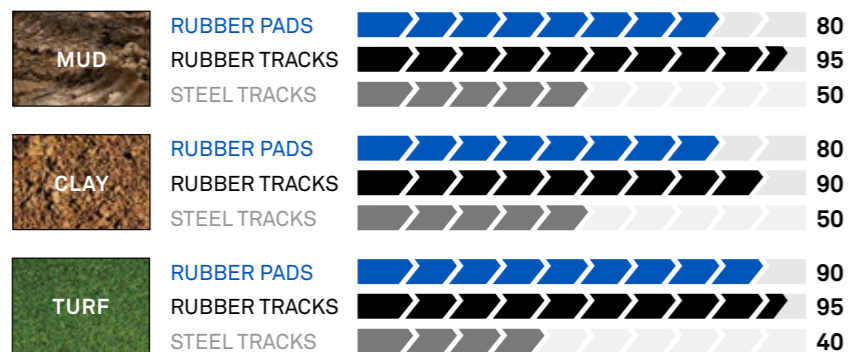

1 Bi-Directional HXD tread pattern

- Ultimate off-road traction and durability

2 Premium HXD rubber compound

- Provides ultimate durability and resistance to catastrophic failures

3 Forged metal core with CutProtect bonding technology

- Maximizes track pad life with cut resistant geometry that's been engineered for ultimate durability

4 Anti-Edge cut

- Provides maximal protection against side cuts and tears

*Check with your dealer for best choice for your application

BEST WARRANTY OFFER

CAMSO HXD

UP TO 20% MORE SERVICE LIFE

3000 / 36 HOURS / MONTHS

COMPACT TRACK LOADER TRACKS

ULTIMATE VERSATILITY, REMARKABLE TRACTION, AND EXCELLENT DURABILITY IN A VARIETY OF APPLICATIONS



COMPACT TRACK LOADERS

OVERALL LOSCS GAUGE BY SURFACE
TO OBTAIN THE LOWEST OPERATING COST SOLUTION ON THE MARKET

BEST FOR: Heavy-duty applications requiring exceptional durability*

CTL HXD

SURFACE TYPE

CTL SD

BEST FOR: Applications requiring grip and traction*

HARD SURFACE



MIXED SURFACE



SOFT SURFACE

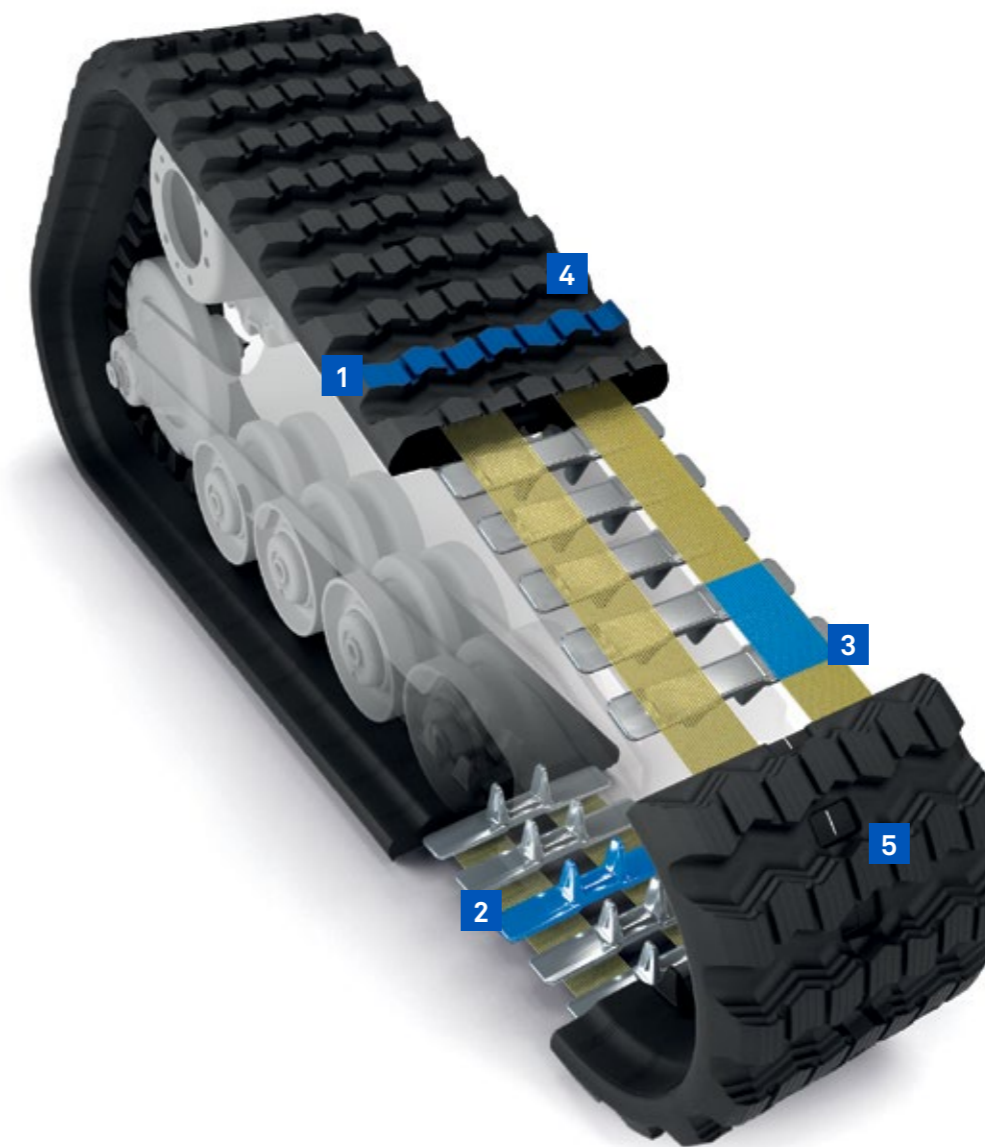

ENGINEERED TREAD PATTERNS

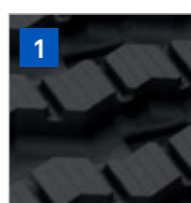
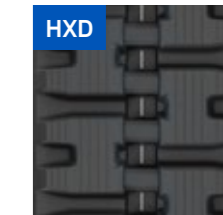

1 Single-cure technology

- Resists catastrophic failure
- Increases durability
- Improves aesthetic appearance



2 Forged metal cores with Trackguard technology

- Improves rolling path life
- Reduces internal component failures



3 Endless high-tensile, rubber-sealed steel cables

- Eliminates joint failures
- Improves cable breakage resistance
- Maximizes and strengthens carcass durability



4 Optimized tread profiles

- Provides excellent traction in any track application
- Provides low rolling resistance hence low energy consumption



5 Self cleaning tread design

- Promotes lug-void cleanout for maximum traction
- Improves productivity and help lower running costs

CAMSO CTL HXD
UP TO 50% MORE SERVICE LIFE
2000 / 24
HOURS / MONTHS

BEST WARRANTY OFFER

CAMSO CTL SD
UP TO 20% MORE SERVICE LIFE
1500 / 18
HOURS / MONTHS

*Check with your dealer for the best track choice for your application

COMPACT TRACK LOADER SPROCKETS
**OEM QUALITY AND PERFORMANCE
 AT AFTERMARKET PRICES**



COMPACT TRACK
 LOADERS



- 1 Enhanced hardening with deeper penetration**
 Provides longer sprocket wear
- 2 Premium quality design and engineering**
 Meets the toughest OEM specifications
- 3 Optimized geometry and design**
 Ensures best fitment with tracks for longer track life

MULTI-TERRAIN LOADER TRACKS
ENHANCED DURABILITY AND PROTECTION



MULTI TERRAIN
 LOADERS

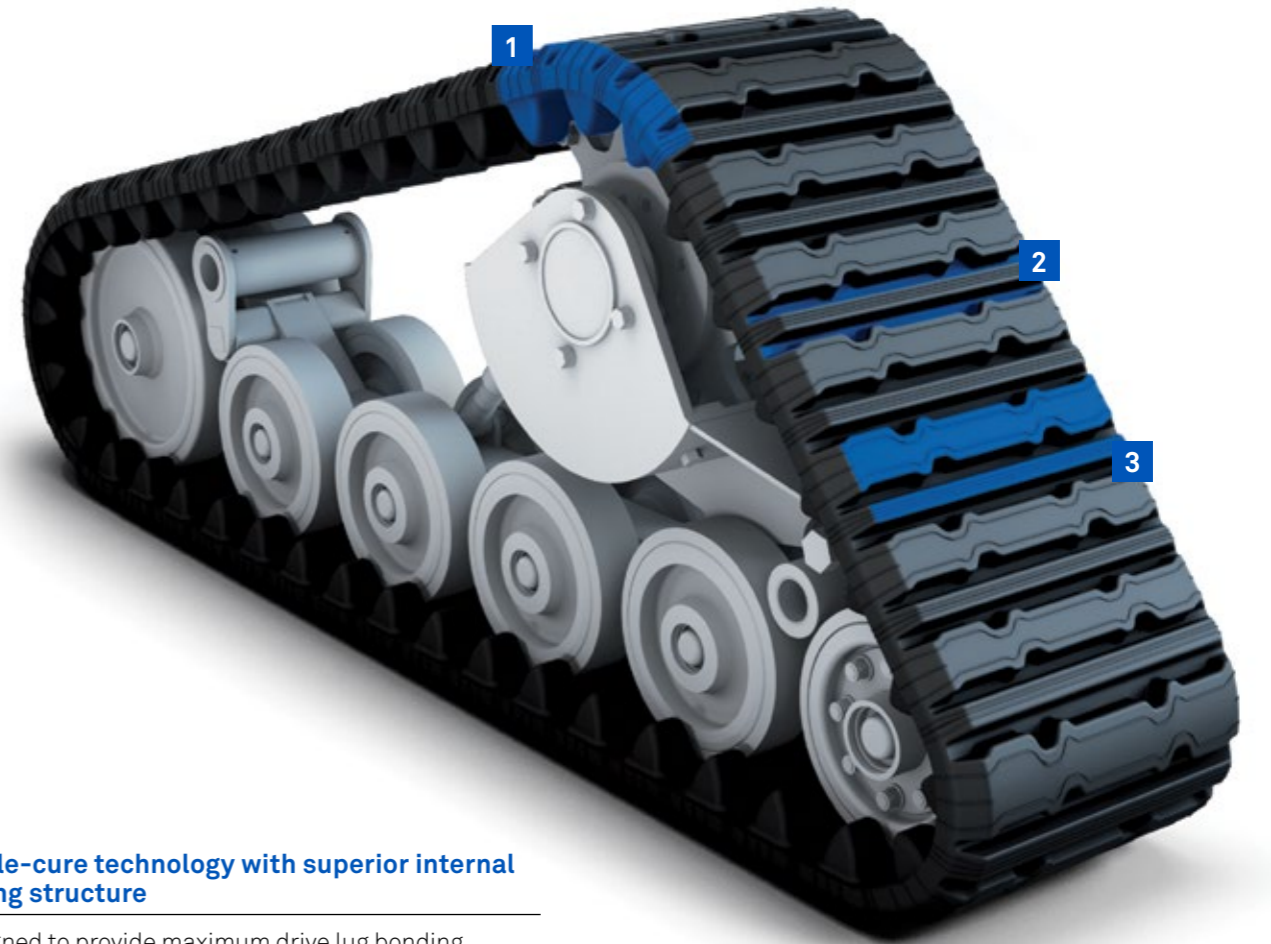

- 1 Single-cure technology with superior internal casing structure**
 Designed to provide maximum drive lug bonding and utilisation life.
- 2 Heavy duty carcass construction**
 Increases lateral stability to eliminate detracking for more uptime
- 3 Versatile tread pattern matched with advanced rubber compound**
 Maintains good traction throughout tread life

**BEST
 WARRANTY
 OFFER**

**CAMSO
 CTL SPROCKET**

1500 / 18
 HOURS MONTHS

**BEST
 WARRANTY
 OFFER**

**CAMSO
 MTL HXD**

**50%
 MORE
 SERVICE LIFE** | **1200 / 14**
 HOURS MONTHS

OVER-THE-TYRE TRACKS

EASY MOUNT ATTACHMENTS FOR SKID STEERS THAT PROVIDE TRACTION AND FLOTATION ONLY CAPABLE WITH TRACKS



Easy-mounting design

Mount in a matter of minutes on most skid steer makes and models.



OVERALL LOCS GAUGE BY SURFACE TO OBTAIN THE LOWEST OPERATING COST SOLUTION ON THE MARKET

BEST FOR: Applications requiring extraordinary flotation and minimizing surface disturbance

RUBBER

SURFACE TYPE

STEEL

BEST FOR: Applications requiring extreme durability and additional penetrating traction

HARD SURFACE



MIXED SURFACE



SOFT SURFACE



CAMSO RUBBER OTT



1 Full rubber track reinforced with steel core and cables

Allows smoother operation on asphalt, concrete and turf surfaces without damage or marking

2 Wide continuous rubber track footprint

Increases flotation by 5 times compared to tyres alone, and at least twice as much as standard steel tracks

3 Embedded forged metal core with engineered wing design

Ensures strength and rigidity to avoid detracking

4 Internal traction rib

Provides high traction between tyre and track and prevents tyre wear

CAMSO STEEL OTT

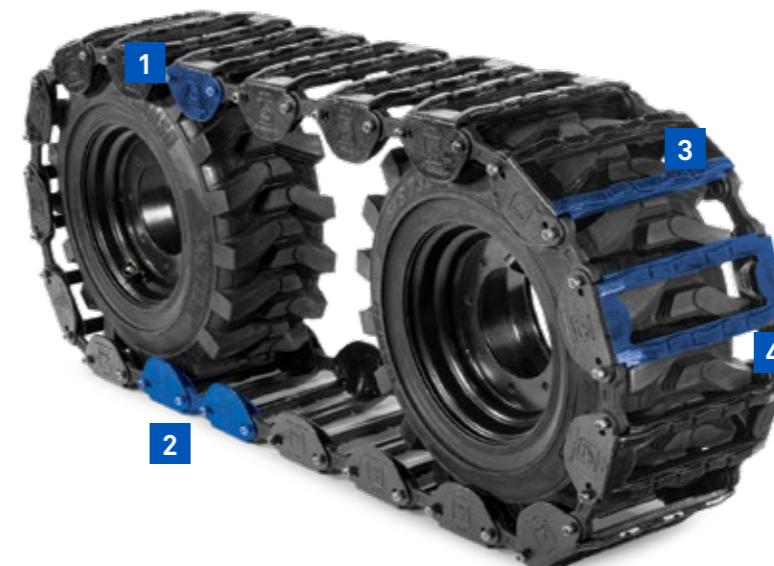

1 Case-hardened all-steel track construction

Maximizes durability and performance in severe applications

2 Customizable sizing with variable pitch design

Facilitates easy product selection and installation

3 Engineered high-traction tread bar

Provides enhanced all-around traction especially on open side slopes and unprecedented traction on ice

4 Wide-void design

Enhances debris and rock cleanout providing optimum traction on soft surfaces

CAMSO RUBBER OTT

12 MONTHS

BEST WARRANTY OFFER

CAMSO STEEL OTT

24 MONTHS

*Check with your dealer for best choice for your application

HIGH PERFORMANCE IN THE MOST SEVERE APPLICATIONS

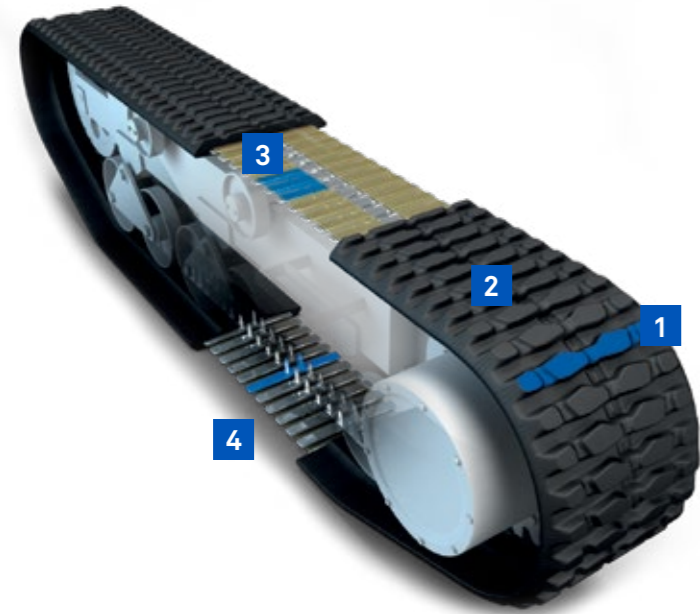

CARRIERS

- 1 Straight bar tread pattern**
Modernised tread design for higher performance and productivity
- 2 Next generation rubber compound**
Promotes even tread wearing for long, predictable tread life
- 3 Endless steel cable technology**
Protects from joint failures to maximize uptime
- 4 Trackguard iron core**
Improves rolling path life for reduced failures and enhanced durability

BEST WARRANTY OFFER

CAMSO CARRIER | **1000 / 12**
HOURS MONTHS

ENHANCED DURABILITY CROSS MULTIPLE SURFACE TYPES



PAVERS

- 1 Single-cure technology with next generation rubber compound**
Promotes even tread wearing for long, predictable tread life
- 2 Optimized multi layer internal construction**
Improves weight distribution with better lateral stiffness
- 3 Chevron type tread pattern**
Provides high traction in softer surfaces

BEST WARRANTY OFFER

CAMSO PAVER | **1500 / 18**
HOURS MONTHS



THE CAMSO DIFFERENCE



At Camso we achieved an edge on our competition by differentiating ourselves in three specific ways:

1 CAMSO is a leading manufacturer of OEM brands

Camso is a proud supplier of the world's best known construction brands. We have achieved our OEM positions through close collaboration, co-development, and validation with leading equipment manufacturers. Working with the OEM's has pushed our products to new levels of toughness and represents a symbol of quality and performance end-users can trust.

Many Camso products are also offered through various OEM aftermarket programs.

2 CAMSO offers the best warranty on the market

Actions speak louder than words. This is why we improved our terms and back all of our tracks with an industry leading non-prorated warranty on material and workmanship.

TRACK SERIES	MACHINE TYPE	MONTHS OF SERVICE		HOURS LIMIT	
		OLD	NEW	OLD	NEW
CAMSO SD series	CTL	13	18	1100	1500
	MEX	24	30	2000	2500
CAMSO HXD series	CTL	18	24	1500	2000
	MEX	36	42	3000	3500
	PAD's	N/A	36	N/A	3000
	MTL	14	14	1200	1200
	OTT	12	12	No limit	No limit
	Steel OTT	N/A	24	N/A	No limit

3 CAMSO Construction tracks offer lowest operating cost solution

DURABILITY

CAMSO reduces the total cost of tracks over the machine lifetime with high quality compound.

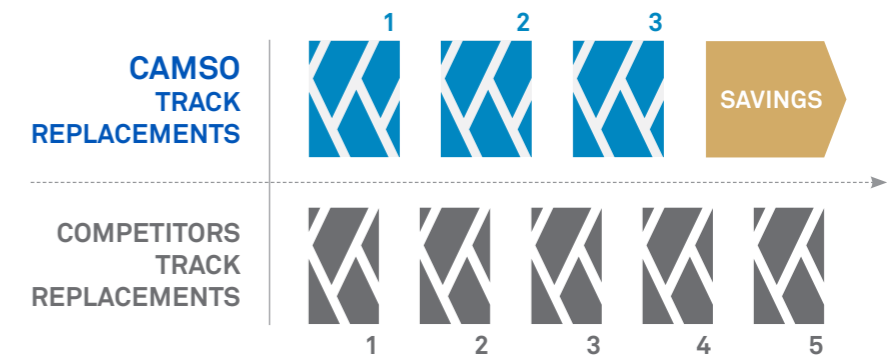

RELIABILITY

CAMSO technology solves problems like detracking and cable breakage to increase uptime over the machine lifetime.



EXCEPTIONAL PERFORMANCE

CAMSO keeps you productive on the job-site with the right products for your application and surface type.



THE CAMSO DIFFERENCE CAMSO tracks reduce the overall amount cost of ownership over your machines lifetime.



CAMSO DIGITAL TOOLS

CAMSO WEBSITE

Developed for those who work and play on a surface that isn't a road, Camso.co provides information and tools wherever and whenever users need them, no matter what device they're using: a phone, a tablet or a computer.

camso.co

- Product selectors for OTR tyres, tracks and track systems for the Construction, Material Handling, Agriculture, and Powersports industries
- Dedicated content such as testimonials, videos, best practices and industry news
- Service and support information including warranty documents, data books and fitment guides
- Contact finder

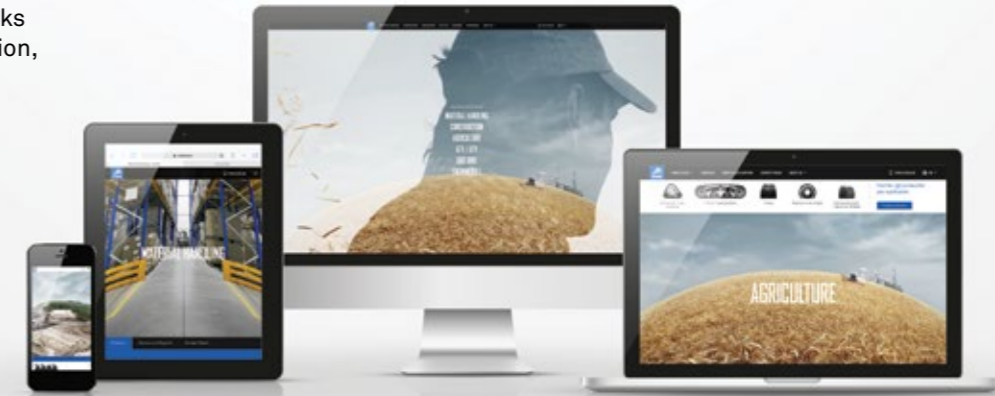

CAMSO CONNECT

connect.camso.co or on the [App Store](#)

Camso connect, previously known as the Si (Sales Intelligence), is a tool that facilitates the explanation of the features and benefits of our Material Handling, Construction and Agricultural products.

- Accessible off-line with the IOs app version
- Complete product information, including features and benefits and product sheets
- 360 views of products and action videos
- Product support information



CONNECT WITH US FOR EXCLUSIVE ROAD FREE CONTENT

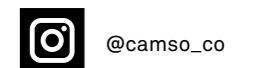
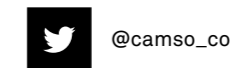
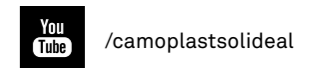
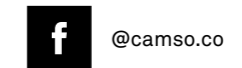

camso.co

