

CAMSO X4S FOR ALL-TERRAIN VEHICLES AND SIDE-BY-SIDE VEHICLES

1099-00-4432

ADJUSTMENTS 2021





INTRODUCTION

These guidelines are designed to provide you with the information necessary to perform the required adjustments to the System. The right adjustments have a direct impact on performance and lifespan of the System's components. It is important to follow closely the instructions contained in this document in order to make the correct system adjustments and thereby reach optimum system performance.

Follow all the instructions contained in this document. To make sure that every step has been performed, a checklist is provided at the end of the instructions to verify that all the adjustments have been made.

IMPORTANT

The warranty does not apply if the Track System was installed by someone other than a Camso dealer or authorized distributor.

IMPORTANT

Verifying your adjustments on the systems is mandatory after the first use of the vehicle; the track tension, alignment and angle of attack of each track system must be re-verified. Incorrect adjustments can decrease the performance of the systems and result in premature wear or breakage of certain components.

IMPORTANT

Before starting the installation, verify that the serial numbers are identical on all 4 track systems. The serial number's last digit (0, 1, 2, 3) indicates the mounting position on the vehicle. Lay out the track systems accordingly. Refer to Figure 1 and Figure 2.

NOTE: If the serial numbers on the track systems do not match, contact your authorized Camso dealer / distributor.

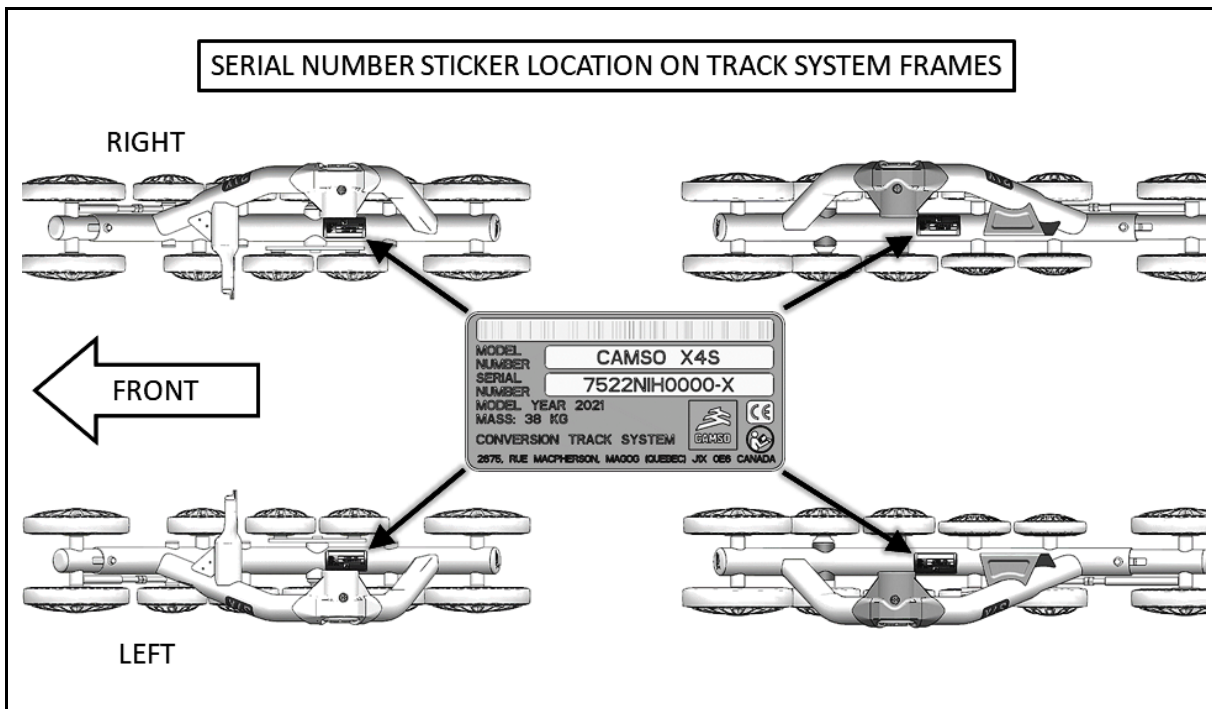

Figure 1

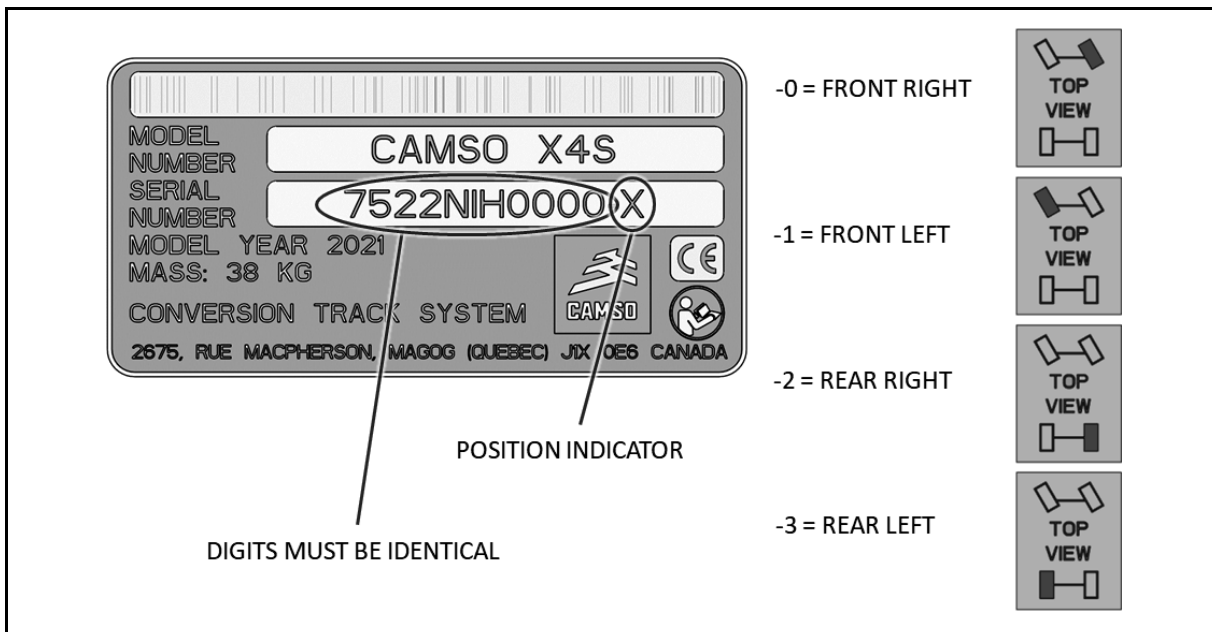

Figure 2

ADJUSTMENTS

CAUTION: After the first use of the vehicle, the adjustment settings (track tension, alignment and angle of attack) on each Track System must be re-verified. Incorrect adjustments can decrease the performance of the System and produce premature wear on certain components.

NOTE: To make the following adjustments, position the vehicle on a flat and level surface.

ANGLE OF ATTACK - FRONT SYSTEMS

To obtain the correct angle of attack on front Track Systems, perform the following:

- Use handlebars to point tracks straight ahead.
- Temporarily apply pressure to the front of the track to make stay flat on the ground
- Stabilizing arm (1) must be attached to front anchor bracket (2) mounted on vehicle. Figure 3.

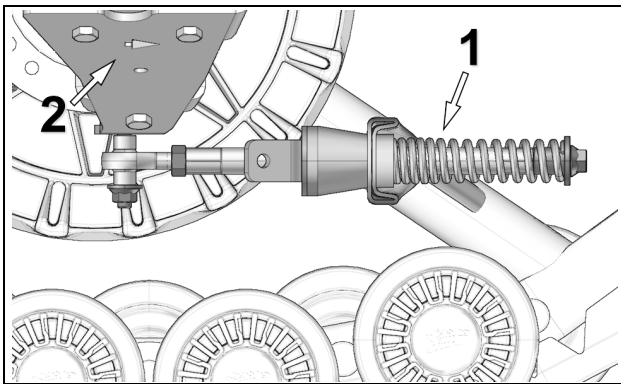

Figure 3

- Position a flat bar on top of rear wheels of front track system and measure from the ground up to flat bar as shown on Figure 4.

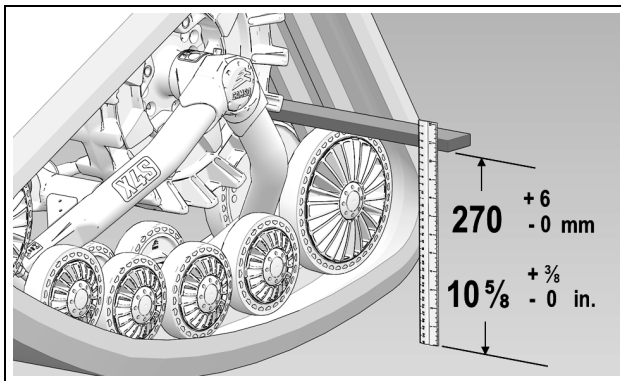

Figure 4

NOTE : Before each measurement, temporarily apply light pressure to the front of the track to make sure that it stays flat on the ground.

- Loosen jam nut (1). Adjust length of rod end (2) by rotating the steering limiter support plate on (3) the stabilizing arm. Use a 30 mm wrench to rotate support plate and obtain **270 mm** above the ground. Refer to Figure 5.

NOTE: The stabilizing arms on front Track Systems incorporate a steering limiter support plate (3) that is bent. This plate should be positioned inwards, towards the vehicle.

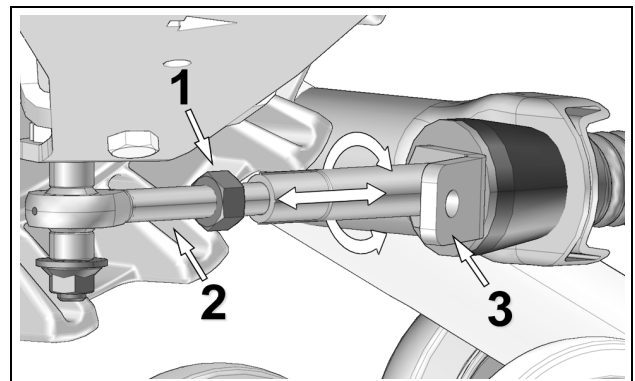

Figure 5

- When angle of attack is correctly set, tighten the jam nut (1) back against the stabilizing arm to 40 N•m [30lb•ft] of torque. See Figure 6.

CAUTION: Follow the recommended torque when tightening the jam nut. Over-tightening the nut might damage the rod end.

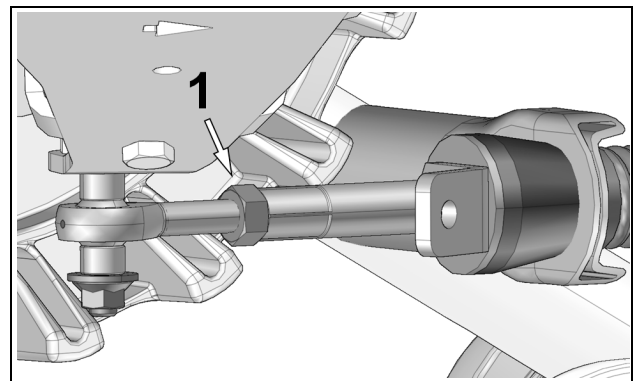

Figure 6

NOTE: Once the angle of attack on the front systems is set, verify once again to confirm the adjustment.

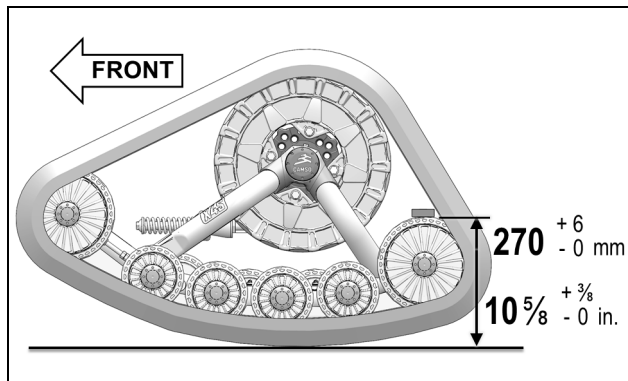

Figure 7

BASIC TUNING (Front Track Systems)

- An adjustment of more than **270 mm** [10 5/8 in.], measured with the flat bar, provides easier steering but produces a wobbling effect at high speed.
- An adjustment of less than **270 mm** [10 5/8 in.], measured with the flat bar, results in harder steering and more stability at high speed.

ANGLE OF ATTACK - REAR SYSTEMS

To obtain the correct angle of attack on rear Track Systems, perform the following:

RIGID AXLE OR TRAILING ARM SUSPENSION

CAUTION: Some vehicles require a particular adjustment. Refer to the *Installation Guidelines* specific to your vehicle model to confirm the adjustment.

- Stabilizing arm (1) must be attached to Track System and to rear anchor bracket (2) installed on vehicle. See Figure 8.

NOTE: Actual Rear Anchor bracket (2) mounted on vehicle may differ from the one in the illustration.

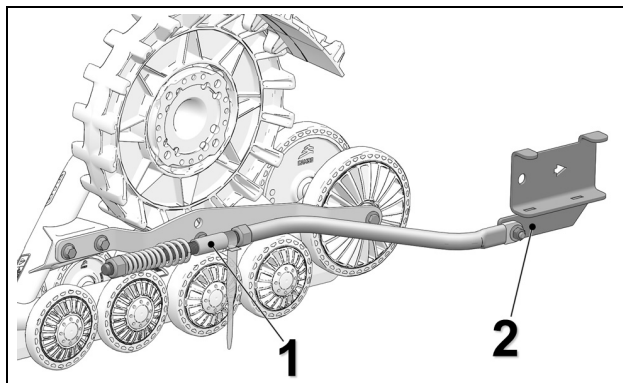

Figure 8

- Loosen nut (3) compressing stabilizing rod spring. See Figure 9.

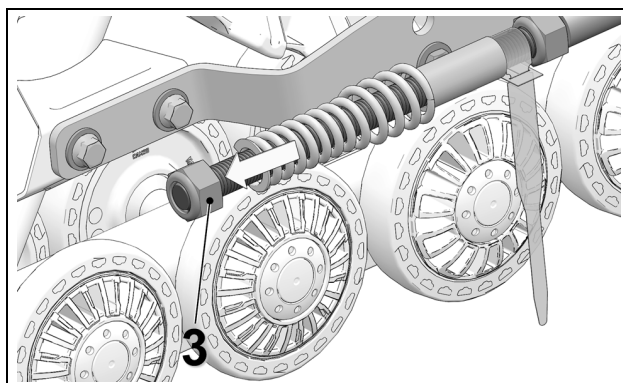

Figure 9

NOTE: Use narrow part of adjusting template, provided with stabilizing arm, to make adjustment.

- Set nut (4) to obtain a distance of 10 mm between nut and stabilizing arm guide as shown on Figure 10.

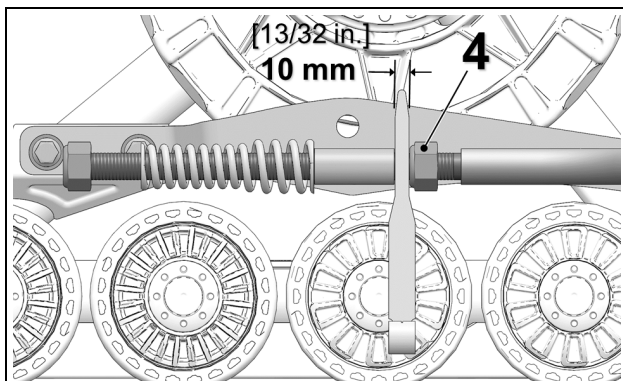

Figure 10

- Turn nut (3) until it comes in contact with spring, then compress spring by rotating nut 1 1/2 turns. See Figure 11.

ADJUSTMENTS

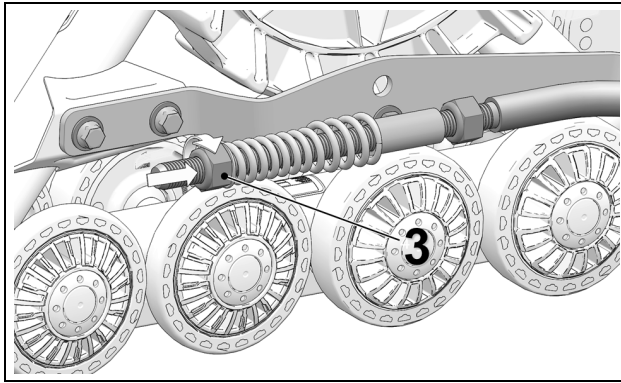

Figure 11

- **IMPORTANT:** Double-check the 10 mm minimum distance between nut and stabilizing arm guide. Re-adjust as needed. Figure 12.

NOTE: Use the provided template to double-check the adjustment.

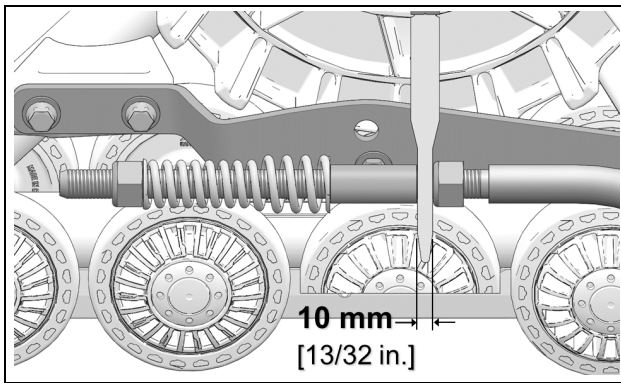

Figure 12

INDEPENDENT SUSPENSION (IS)

- Stabilizing arm (1) must be attached to rear anchor bracket (2) installed on vehicle. Figure 13.

NOTE: Actual Rear Anchor bracket (2) mounted on vehicle may differ from the one in the illustration.

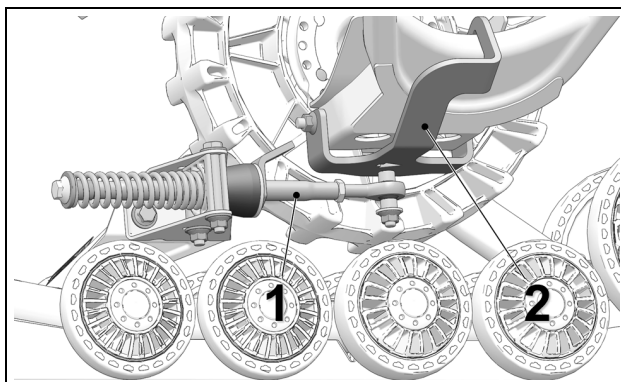

Figure 13

- Loosen anti-rotation bracket bolts (3) to allow the anti-rotation retainer (4) to rotate on its axis. See Figure 14.

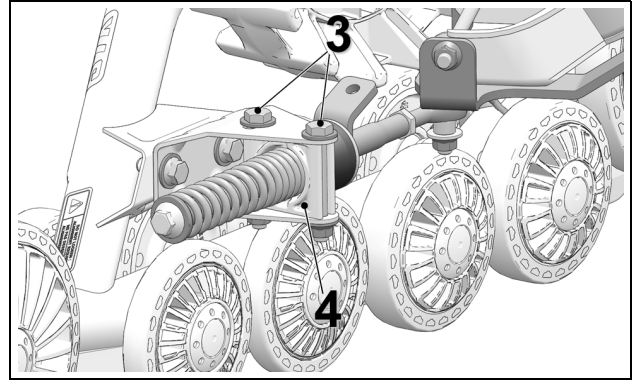

Figure 14

- Loosen jam nut (5). Turn stabilizing arm (1) to adjust length of rod end (6) so that rubber cone (7) applies light pressure on anti-rotation retainer (4). Figure 15.

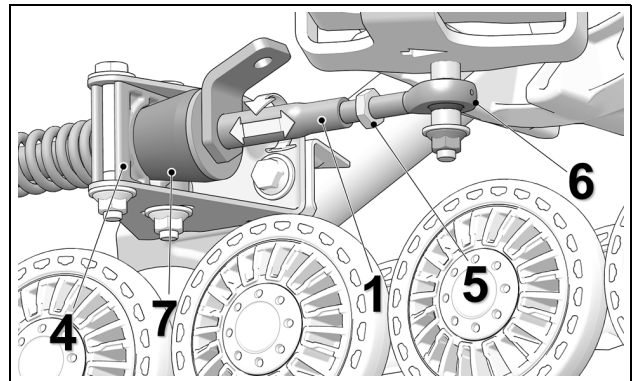

Figure 15

- Re-tighten jam nut (5) to 40 N•m [30 lb-ft] of torque when adjustment is complete. Figure 16.

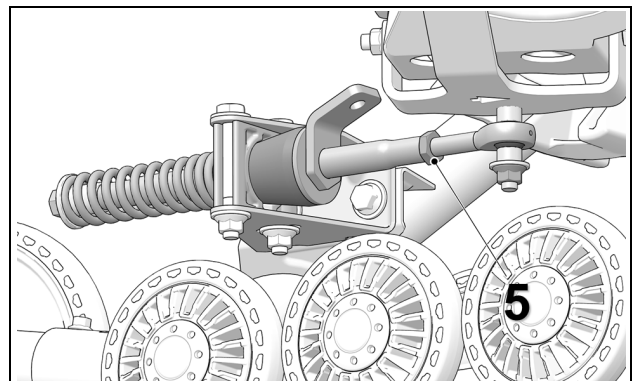

Figure 16

CAUTION: Tighten the jam nut to the recommended torque specification. Overtightening the nut might damage the rod end.

- Re-tighten anti-rotation bracket bolts (3) to 50 N•m [37 lb-ft] of torque. See Figure 17.

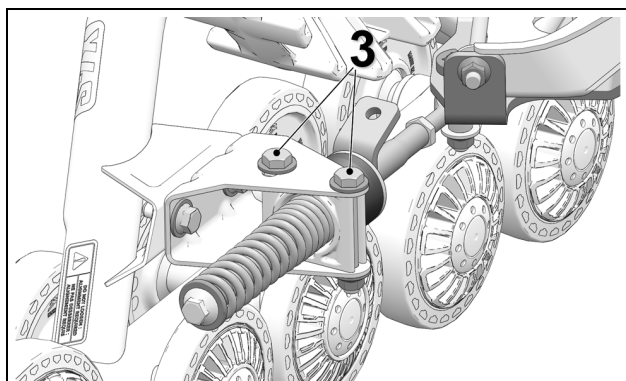

Figure 17

NOTE: Once the angle of attack on the rear systems is set, verify once again to confirm the adjustment.

BASIC TUNING (Rear Track Systems)

- The adjustment is **incorrect** when the stabilizing arm's rubber cone is compressed and deformed. The stabilizing arm's spring is then difficult or impossible to turn by hand.

TRACK SYSTEM REMOVAL

CAUTION: Leaving the anti-rotation anchor brackets attached to the suspension arms, after having removed the Track Systems, could cause interference which might damage the vehicle. Remove all Track System anti-rotation mechanism components installed on the vehicle before reinstalling the wheels.

CAUTION: Track Systems mounted on an ATV or SxS increase ground clearance and vehicle stability. Be careful after re-installing your wheels; the handling characteristics of the vehicle will differ from those produced by Track Systems.

ALIGNMENT

Parallelism must be adjusted with the vehicle on the ground, driving forward about 3 meters [10 ft.] and measuring toe-in distance. See Figure 18.

NOTE: Every time the measurement has to be taken, drive in reverse, then, drive forward again on about 3 meters [10 ft.].

CAUTION: Verify condition of steering system components before adjusting parallelism. Damaged components can prevent proper adjustment and impair proper operation of the system.

CAUTION: Parallelism adjustment of the front Track Systems is very important and is directly linked to the longevity of the system components. Users must follow attentively the adjustment and verification recommendations of this manual.

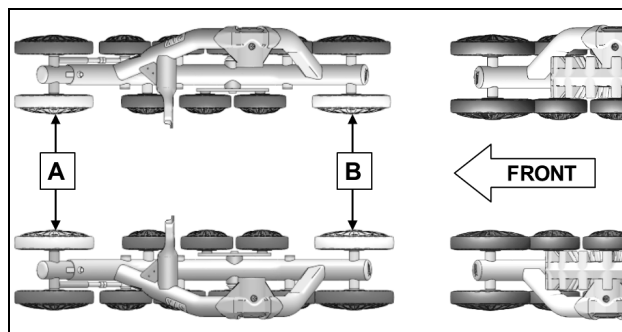

Figure 18

Dimension A: distance between inner front wheels
Dimension B: distance between inner back wheels

Dimension A must be equal to or greater than **dimension B** without exceeding 3 mm [1/8 inch].

A - B = 0 to 3 mm [1/8 inch]

ADJUSTMENTS

Adjustment Method

To adjust the vehicle's steering system, first loosen coupling rod nuts (1), then screw or unscrew the coupling rod (2) an equal number of revolutions on both sides of the vehicle. Retighten nuts when adjustment is complete. See Figure 19 or Figure 20.

NOTE: Starting with an open alignment setting provides a higher degree of precision of the adjustment.

CAUTION: Before loosening coupling rod nuts (1) on the vehicle's steering system, remember that some nuts have reverse threads. Make sure to unlock the nut in the proper rotational direction.

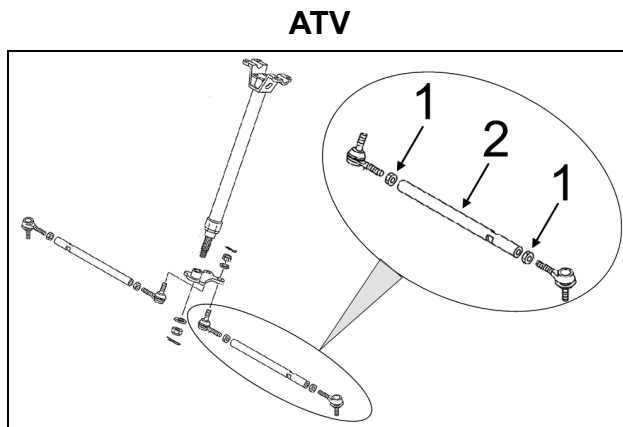

Figure 19

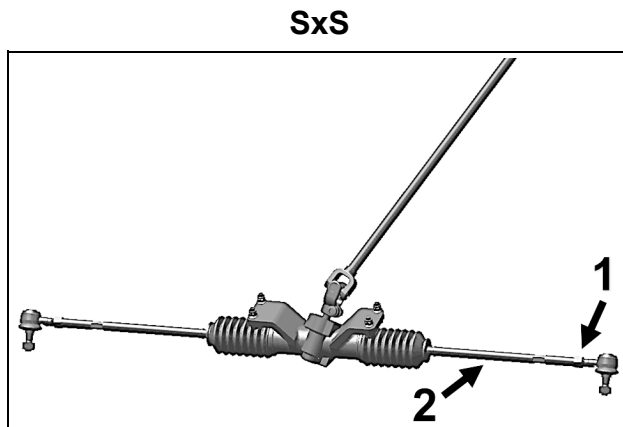

Figure 20

NOTE: Once parallelism of front Systems is set, verify once more to confirm adjustment setting.

Measure A: Measure the distance inside the front $\varnothing 202$ mm wheels on the front Track Systems. See figures 21, 22 and 23.



Figure 21

Measure B: Measure the distance inside the rear $\varnothing 202$ mm wheels on the front Track Systems. See figures 24, 25 and 26.

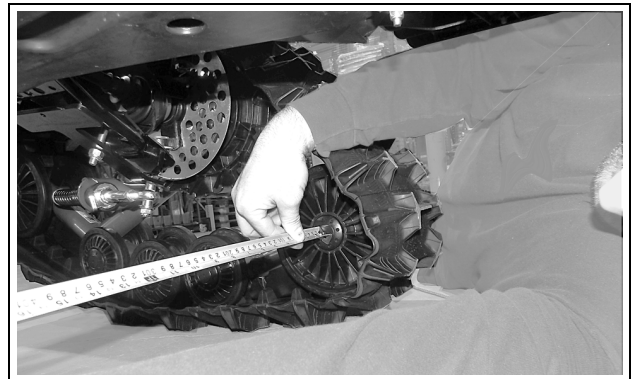

Figure 24



Figure 22 (Distance between front wheels)

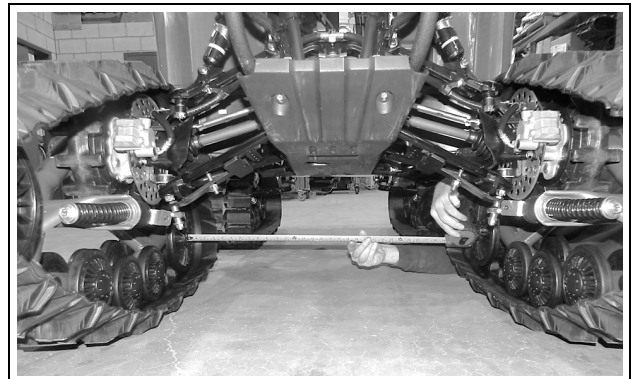

Figure 25 (Distance between rear wheels)



Figure 23

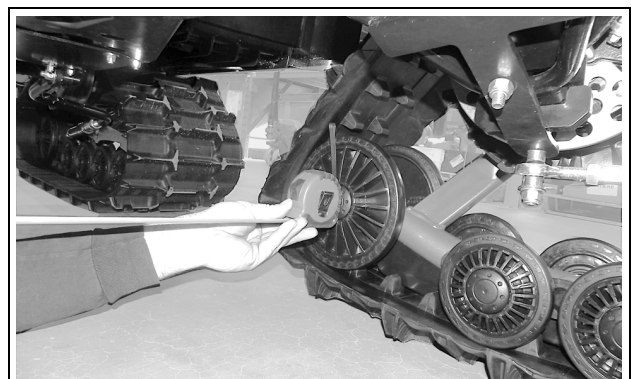

Figure 26

ADJUSTMENTS

TRACK TENSION

⚠ WARNING
 The tensioner assembly bolt must never be loosened while adjusting the track tension. This bolt is designed for assembly and alignment of the tensioner with the frame. The tensioner must always be realigned when this bolt is loosened.

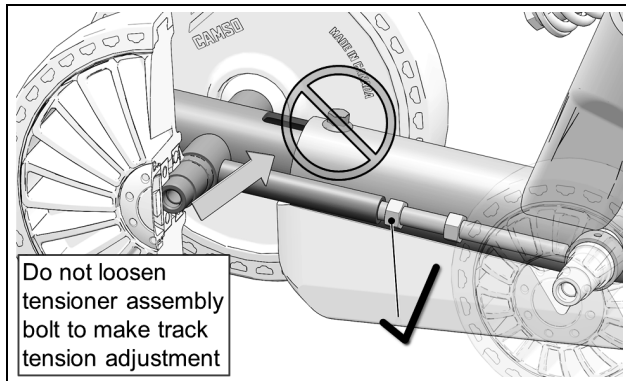

Figure 27

- Loosen jam nut (1) and turn adjusting nut (2) to set track tension. See Figure 28.

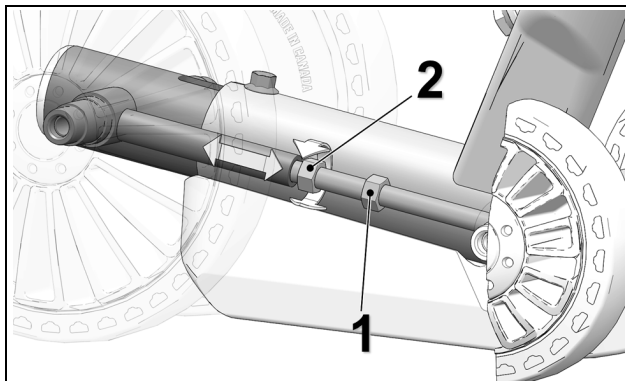

Figure 28

- The table below shows the force (3) applied and the deflection (4) which must occur to correctly set track tension. See also Figure 30.

SEASON	TRACK	FORCE	DEFLECTION
SUMMER	Front	15 kg (33 lb)	19 mm (¾ in.)
	Rear	15 kg (33 lb)	19 mm (¾ in.)
WINTER (snow)	Front	11 kg (24 lb)	19 mm (¾ in.)
	Rear	11 kg (24 lb)	19 mm (¾ in.)

NOTE: The track tension testing tool, shown below in Figure 29, can be purchased through an authorized Camso dealer. Part #2000-00-3125.



Figure 29

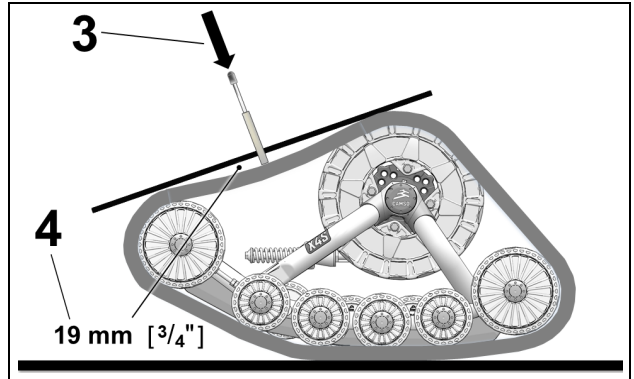

Figure 30

BASIC TUNING

- Higher rubber track tension reduces the risk of “derailing” and reduces sprocket “ratcheting”.

NOTE: Track tension set too high could cause premature wear on system components and is therefore not recommended.

- Lower rubber track tension provides better traction, a smoother ride and better fuel economy.

Final Check

Ride at slow speed on a distance of about 1.5 km [1 mile]. Re-adjust as required.

CAUTION: Minor installation problems could present themselves on some vehicles due to interference between system components and the vehicle. Refer to the section entitled “COMPLETION” in the *Installation Guidelines* for instructions on how to work out these installation problems

**CAMSO X4S TRACK SYSTEMS
INSTALLATION AND ADJUSTMENT CHECKLIST**

**** Steps in this checklist are laid out in logical order. They should be performed in succession to optimize the track system installation on the vehicle. ****

1 - COMPONENT INSTALLATION

✓

A - INSTALLATION OF REAR ANCHOR BRACKETS

** Refer to INSTALLATION GUIDELINES section entitled "Rear track systems"*

B - INSTALLATION OF FRONT ANCHOR BRACKETS

** Refer to INSTALLATION GUIDELINES section entitled "Front track systems"*

C - INSTALLATION OF STEERING LIMITERS (if applicable)

** Refer to INSTALLATION GUIDELINES section entitled "Front track systems". ** Do not adjust the Steering Limiter sets before having adjusted the angle of attack.*

2 - COMPONENT ADJUSTMENT

A - ANGLE OF ATTACK

** Refer to ADJUSTMENTS section entitled "Angle of attack"*

B - TRACK ALIGNMENT

** Refer to ADJUSTMENTS section entitled "Track alignment"*

C - TRACK TENSION

** Refer to ADJUSTMENTS section entitled "Track tension"*

D - STEERING LIMITER ADJUSTMENT (if applicable)

** Refer to INSTALLATION GUIDELINES section entitled "Front track systems"*

3 - INTERFERENCE CHECK

IN THE EVENT OF INTERFERENCE BETWEEN THE VEHICLE AND TRACK SYSTEM, SOME PARTS ON THE VEHICLE MAY HAVE TO BE REMOVED OR MODIFIED, OR A LIFT KIT MAY HAVE TO BE INSTALLED. IF APPLICABLE, SEE INSTALLATION GUIDELINES SECTION ENTITLED "COMPLETION".

4 - TEST RUN

1.5 km (1 mile) TEST RUN

5 - POST TEST RUN FINAL CHECKS

A - ANGLE OF ATTACK

** Refer to ADJUSTMENTS section entitled "Angle of attack"*

B - TRACK ALIGNMENT

** Refer to ADJUSTMENTS section entitled "Track alignment"*

C - TRACK TENSION

** Refer to ADJUSTMENTS section entitled "Track tension"*